

TA15

series

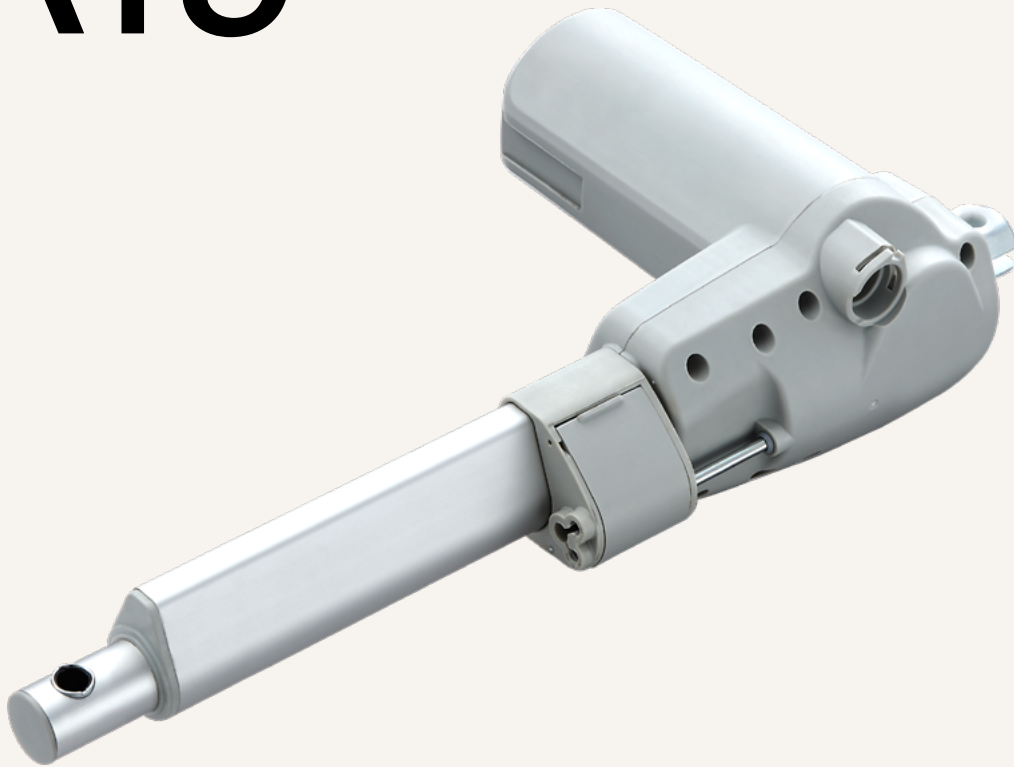

Product Segments

- **Care Motion**

TiMOTION's TA15 series linear actuator was specifically designed for bariatric bed applications. These beds require a robust, long life solution that incorporates safety, reliability and effortless operation. A significant feature of the TA15 linear actuator is the quick release function that allows for lowering of the patient in the event of an emergency or electrical power outage.

General Features

Max. load	10,000N (push); 5,500N (pull)
Max. speed at max. load	4.5mm/s
Max. speed at no load	14.4mm/s
Retracted length	≥ Stroke + 210mm
IP rating	IP66
Certificate	IEC60601-1, ES60601-1, IEC60601-1-2
Stroke	30~800mm
Output signals	POT, Reed, Hall sensors
Voltage	24V/36V DC (thermal protector)
Color	Black, grey
Operational temperature range	+5°C~+45°C
Quick release	

Drawing

Standard Dimensions
(mm)

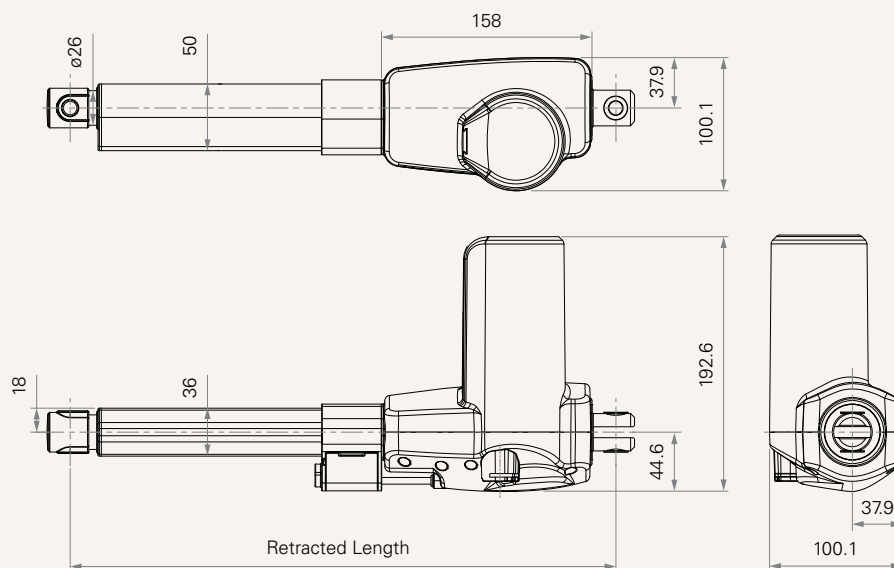

Load and Speed

CODE	Load (N)		Self Locking Force (N)	Typical Current (A)		Typical Speed (mm/s)	
	Push	Pull		No Load 32V DC	With Load 24V DC	No Load 32V DC	With Load 24V DC
Motor Speed (3000RPM, Duty Cycle 10%)							
T	8000	4000	8000	2.5	6.0	7.9	4.4
Motor Speed (3800RPM, Duty Cycle 10%)							
B	10000	4000	10000	2.5	8.5	8.0	4.5
C	8000	4000	8000	2.5	8.5	10.7	6.0
D	5500	5500	5500	2.5	8.0	14.4	8.1

Note

- 1 This self-locking force level is reached only when a short circuit is applied on the terminals of the motor. All the TiMOTION control boxes have this feature built-in.
- 2 The current & speed in table are tested with 24V DC motor. With a 12V DC motor, the current is approximately twice the current measured in 24V DC. With a 36V DC motor, the current is approximately two-thirds the current measured in 24V DC. Speed will be similar for all the voltages.
- 3 The current & speed in table are tested when the actuator is extending under push load.
- 4 Standard stroke: Min. ≥ 30 mm, Max. please refer to below table.

CODE	Load (N)	Max Stroke (mm)
B	10000	500
T, C	8000	500
D	5500	800

Performance Data (24V DC Motor)

Motor Speed (3000RPM, Duty Cycle 10%)

Speed vs. Load

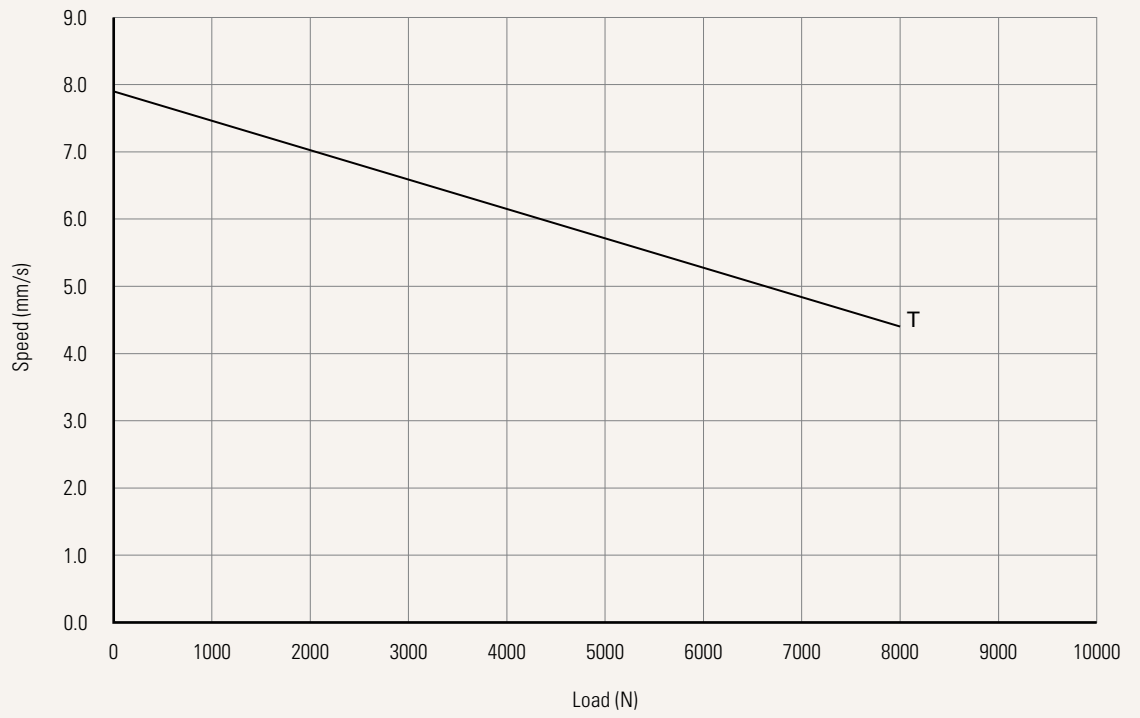

Current vs. Load

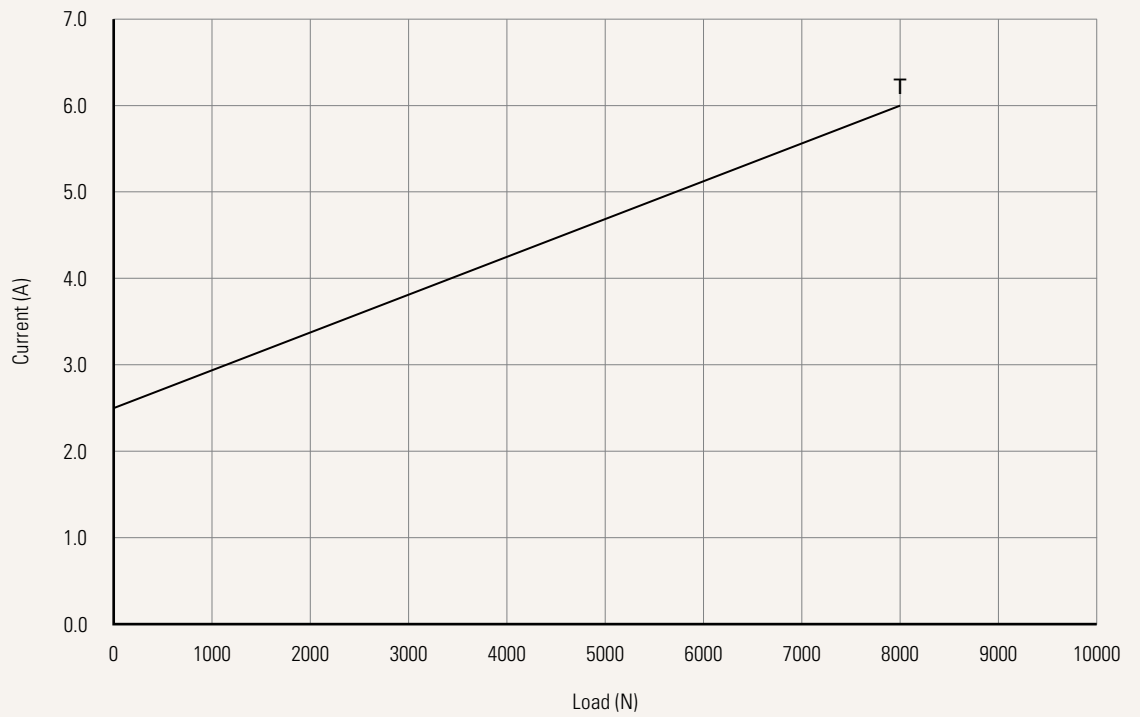

Performance Data (24V DC Motor)

Motor Speed (3800RPM, Duty Cycle 10%)

Speed vs. Load

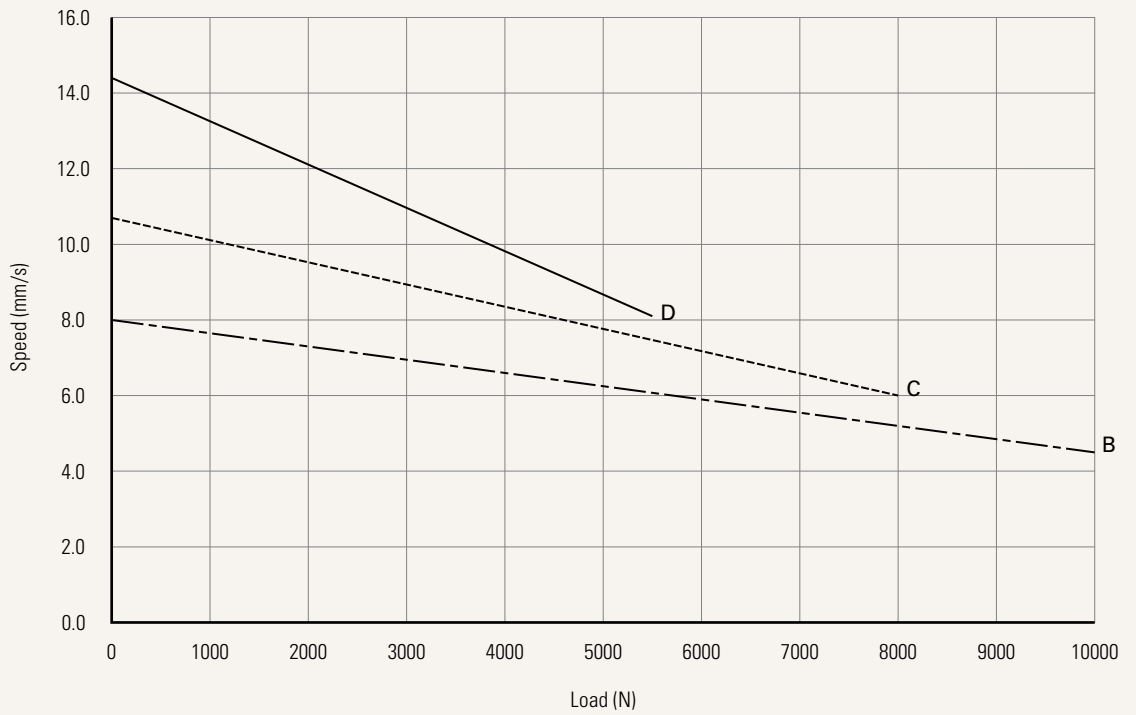

Current vs. Load

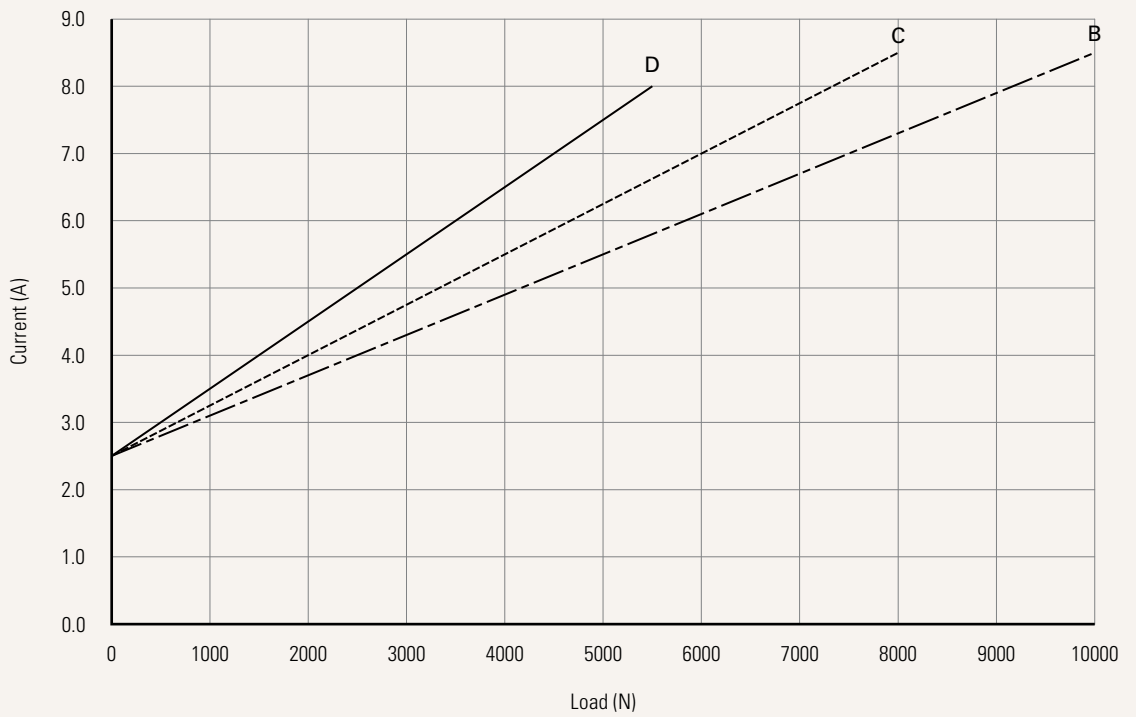

Voltage	5 = 24V, thermal protector 7 = 36V, thermal protector			
Load and Speed	See page 2			
Stroke (mm)	See page 2			
Retracted Length (mm)	See page 6			
Rear Attachment (mm)	1 = Iron CNC, U clevis, slot 8.2, depth 17.0, hole 10.2, T bushing	3 = Iron CNC, U clevis, slot 10.2, depth 17.0, hole 10.2, T bushing		
See page 6	2 = Iron CNC, U clevis, slot 8.2, depth 17.0, hole 12.2	4 = Iron CNC, U clevis, slot 10.2, depth 17.0, hole 12.2		
Front Attachment (mm)	1 = Iron CNC, U clevis, slot 8.2, depth 17.0, hole 10.2, T bushing	3 = Iron CNC, U clevis, slot 10.2, depth 17.0, hole 10.2, T bushing		
See page 6	2 = Iron CNC, U clevis, slot 8.2, depth 17.0, depth 17.0, hole 12.2	4 = Iron CNC, U clevis, slot 10.2, depth 17.0, hole 12.2		
Direction of Rear Attachment (Counterclockwise)	1 = 0°	3 = 90°		
See page 7				
Color	1 = Black	2 = Pantone 428C		
IP Rating	1 = Without	2 = IP54	3 = IP66	
Quick Release	0 = Without	2 = Cable type quick release (not including cable)		
Special Functions for Spindle Sub-Assembly	0 = Without (Standard)	2 = Standard push only		
	1 = Safety nut	3 = Standard push only + safety nut		
Functions for Limit Switches	1 = Two switches at full retracted / extended positions to cut current	3 = Two switches at full retracted / extended positions to send signal		
See page 7	2 = Two switches at full retracted / extended positions to cut current + third one in between to send signal	4 = Two switches at full retracted / extended positions to send signal + third one in between to send signal		
Output Signal	0 = Without	2 = Hall sensors * 2	3 = Reed Sensor	4 = POT
Connector	0 = DIN 6P, socket on gear box	2 = Tinned leads	E = Molex 8P, plug	Q = Molex 6P, 90° plug
See page 7-8	1 = DIN 6P, 90° plug	3 = Small 01P, plug	F = DIN 6P, 180° plug	
		4 = Big 01P, plug	G = Audio plug	
Cable Length (mm)	0 = Without, for socket on gear box	1 = Straight, 500	5 = Straight, 1500	7 = Curly, 200
		3 = Straight, 1000	6 = Straight, 2000	8 = Curly, 400

Retracted Length (mm)

1. Calculate $A+B+C = Y$
2. Retracted length needs to $\geq \text{Stroke}+Y$

A. Front Attach.

1, 2, 3, 4	+220
B, C	+210

C. Load.

B	+5
T, C, D	-

B. Stroke (mm)

0~150	-
151~200	-
201~250	-
251~300	-
301~350	+10
351~400	+20

* For stroke over 300mm, +10mm for each increment of 50mm stroke.

Rear Attachment (mm)

1 = Iron CNC, U clevis, slot 8.2, depth 17.0, hole 10.2, T bushing

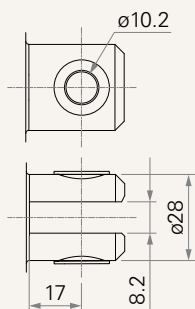

2 = Iron CNC, U clevis, slot 8.2, depth 17.0, hole 12.2

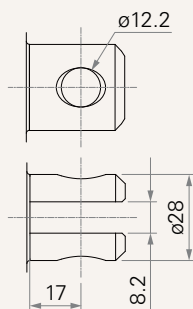

3 = Iron CNC, U clevis, slot 10.2, depth 17.0, hole 10.2, T bushing

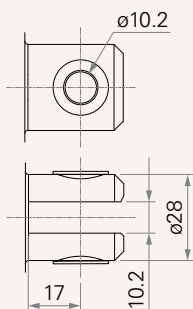

4 = Iron CNC, U clevis, slot 10.2, depth 17.0, hole 12.2

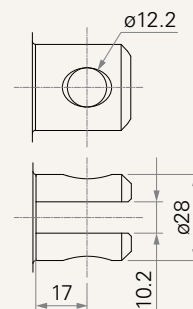

Front Attachment (mm)

1 = Iron CNC, U clevis, slot 8.2, depth 17.0, hole 10.2, T bushing

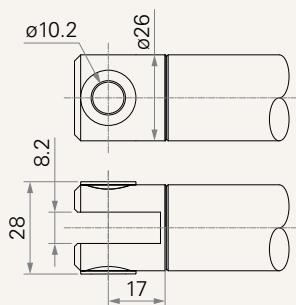

2 = Iron CNC, U clevis, slot 8.2, depth 17.0, depth 17.0, hole 12.2

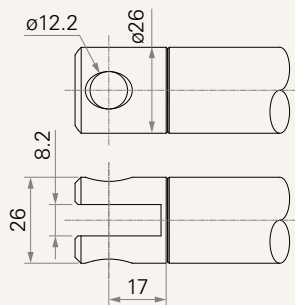

3 = Iron CNC, U clevis, slot 10.2, depth 17.0, hole 10.2, T bushing

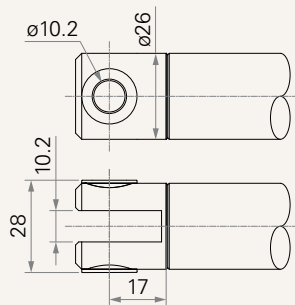

4 = Iron CNC, U clevis, slot 10.2, depth 17.0, hole 12.2

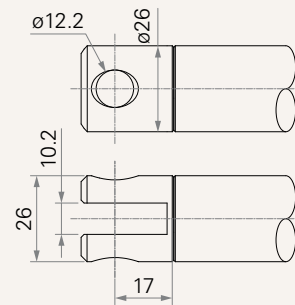

Direction of Rear Attachment (Counterclockwise)

1 = 0°

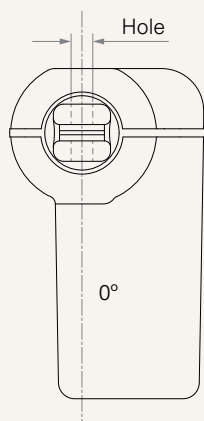

3 = 90°

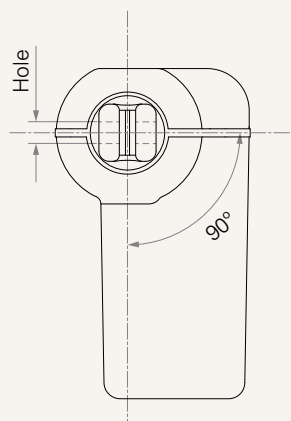

Functions for Limit Switches

Wire Definitions

CODE	Pin					
	● 1 (Green)	● 2 (Red)	○ 3 (White)	● 4 (Black)	● 5 (Yellow)	● 6 (Blue)
1	extend (VDC+)	N/A	N/A	N/A	retract (VDC+)	N/A
2	extend (VDC+)	N/A	middle switch pin B	middle switch pin A	retract (VDC+)	N/A
3	extend (VDC+)	common	upper limit switch	N/A	retract (VDC+)	lower limit switch
4	extend (VDC+)	common	upper limit switch	medium limit switch	retract (VDC+)	lower limit switch

Connector

0 = DIN 6P, socket on gear box

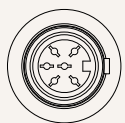

1 = DIN 6P, 90° plug

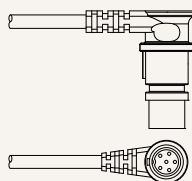

2 = Tinned leads



3 = Small 01P, plug

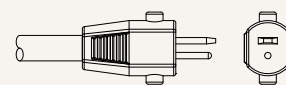

4 = Big 01P, plug

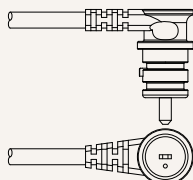

E = Molex 8P, plug

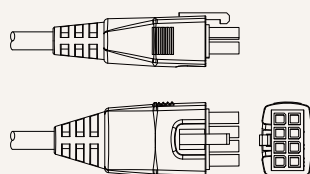

F = DIN 6P, 180° plug

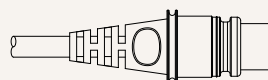

G = Audio plug



Connector

Q = Molex 6P, 90° plug

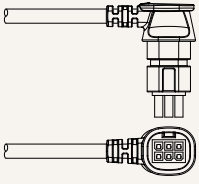

Terms of Use

The user is responsible for determining the suitability of TiMOTION products for a specific application. TiMOTION products are subject to change without prior notice.