

TA4

series

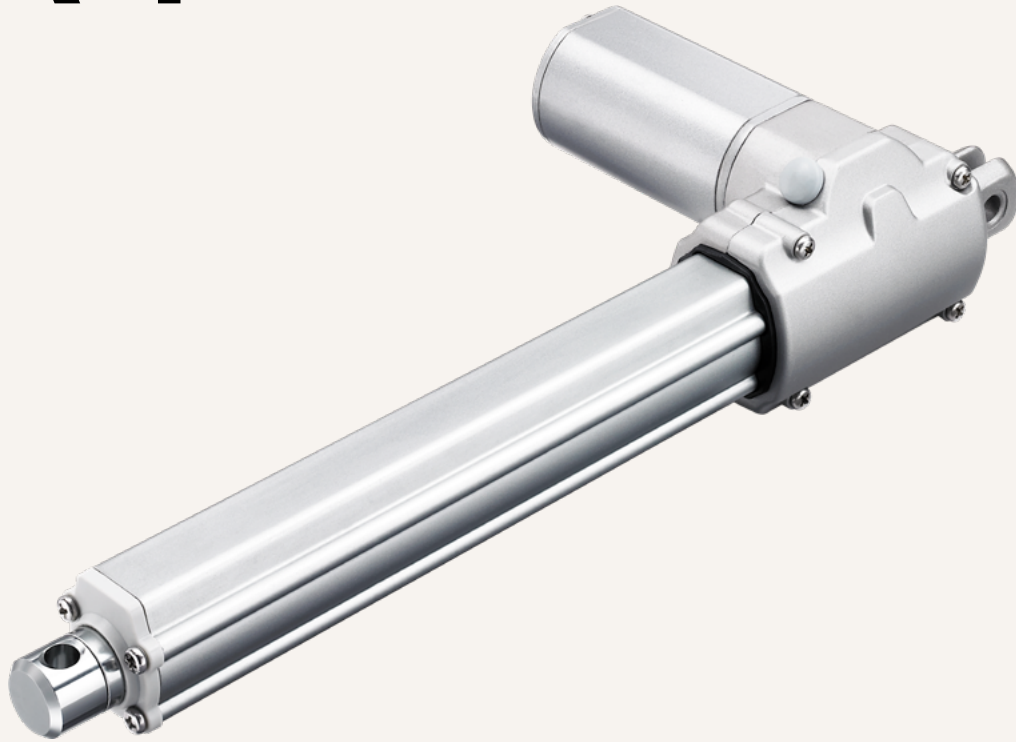

Product Segments

- **Comfort Motion**

TiMOTION's TA4 series linear actuator is compact, quiet and powerful. It is designed to fit in an area specifically requiring a right angle motor and can be equipped with a Hall sensor for feedback. Certifications for the TA4 linear actuator include IEC60601-1, ES60601-1, UL73 and EMC. In addition, the TA4 is available with an optional IP54 or 66 rating.

General Features

Max. load	3,500N (push); 2,000N (pull)
Max. speed at max. load	3.1mm/s
Max. speed at no load	36.9mm/s
Retracted length	≥ Stroke + 140mm
IP rating	IP66
Certificate	IEC60601-1, ES60601-1, UL73, EMC
Options	Hall sensors
Voltage	12/24V DC; 24V DC (PTC)
Color	Silver
Operational temperature range	+5°C~+45°C
Low noise	

Drawing

Standard Motor Dimensions
(mm)

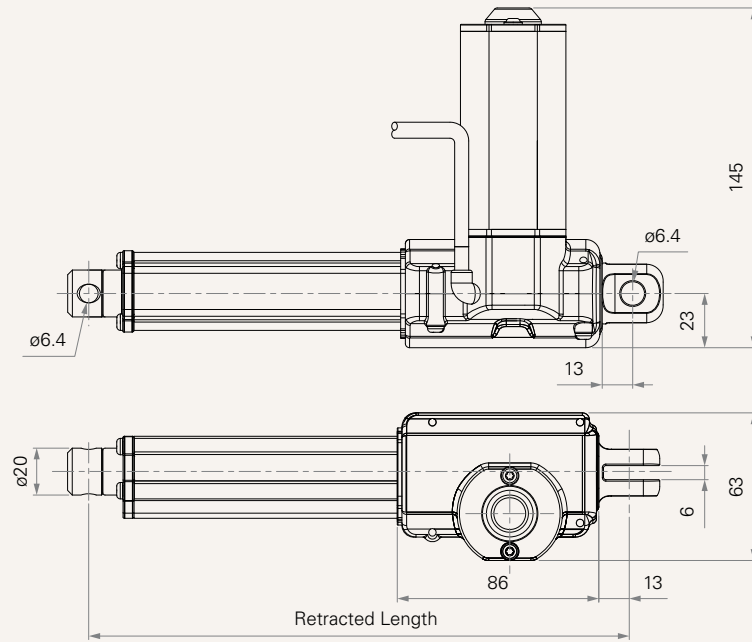

Short Motor Dimensions
(mm)

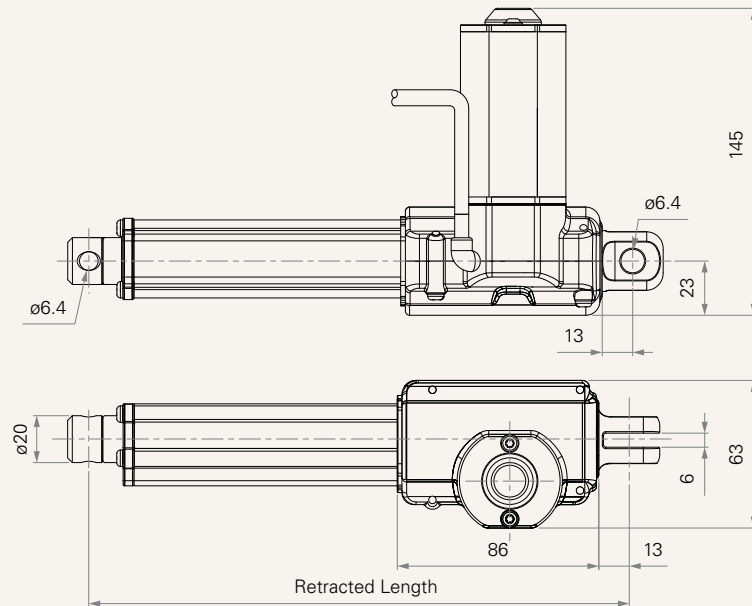

Load and Speed

CODE	Load (N)		Self Locking Force (N)	Typical Current (A)		Typical Speed (mm/s)	
	Push	Pull		No Load 32V DC	With Load 24V DC	No Load 32V DC	With Load 24V DC
Motor Speed (4100RPM, Duty Cycle 10%)							
A	2000	2000	2000	1.0	2.5	9.4	5.0
B	1500	1500	1500	1.0	2.5	13.8	6.8
C	1000	1000	1000	1.0	3.0	26.1	11.6
D	800	800	800	1.0	2.8	36.9	16.6
E	3500	2000	3500	1.0	2.8	6.1	2.3
Motor Speed (3800RPM, Duty Cycle 10%)							
G	2500	2000	2500	1.1	2.7	9.3	5.1
H	2000	2000	2000	1.1	2.9	13.2	7.0
I	1500	1500	1500	1.1	3.5	26.0	12.5
J	3500	2000	3500	1.1	2.8	6.2	3.1
Motor Speed (3400RPM, Duty Cycle 10%)							
M	1500	1500	1500	0.8	1.6	8.1	3.8
N	1000	1000	1000	0.8	1.4	11.6	5.9
O	500	500	500	0.8	1.4	21.9	11.3
Motor Speed (2200RPM, Duty Cycle 10%)							
R	1500	1500	1500	0.8	1.4	8.1	3.7
S	1000	1000	1000	0.8	1.5	16.5	6.9
T	800	800	800	0.8	1.4	22.5	10.0

Note

- 1 Please refer to the approved drawing for the final authentic value.
- 2 This self-locking force level is reached only when a short circuit is applied on the terminals of the motor. All the TiMOTION control boxes have this feature built-in.
- 3 The current & speed in table are tested with 24V DC motor. With a 12V DC motor, the current is approximately twice the current measured in 24V DC; speed will be similar for both voltages.
- 4 The current & speed in table are tested when the actuator is extending under push load.
- 5 The current & speed in table and diagram are tested with TiMOTION control boxes, and there will be around 10% tolerance depending on different models of the control box. (Under no load condition, the voltage is around 32V DC. At rated load, the voltage output will be around 24V DC)
- 6 Standard stroke: Min. ≥ 20 mm, Max. please refer to below table.

CODE	Load (N)	Max Stroke (mm)
C, D, N, O, S, T	≤ 1000	600
B, I, M, R	≤ 1500	500
A, H	≤ 2000	450
G	≤ 2500	400
E, J	≤ 3500	350

Performance Data (24V DC Motor)

Motor Speed (4100RPM)

Speed vs. Load

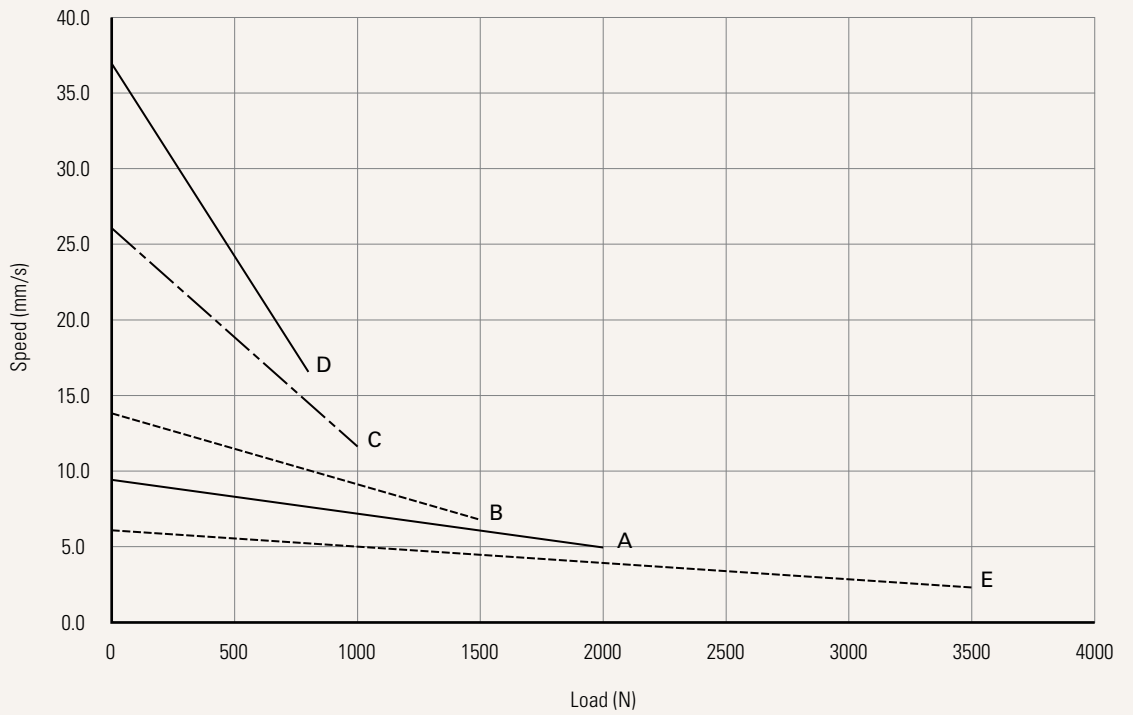

Current vs. Load

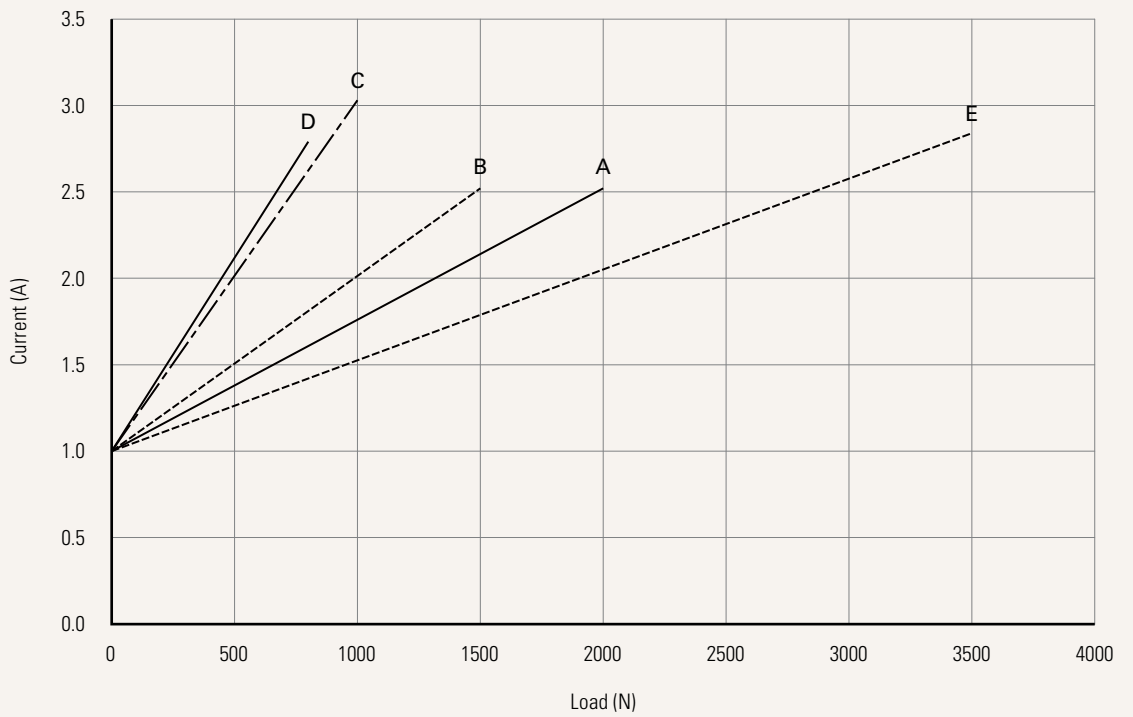

Performance Data (24V DC Motor)

Motor Speed (3800RPM)

Speed vs. Load

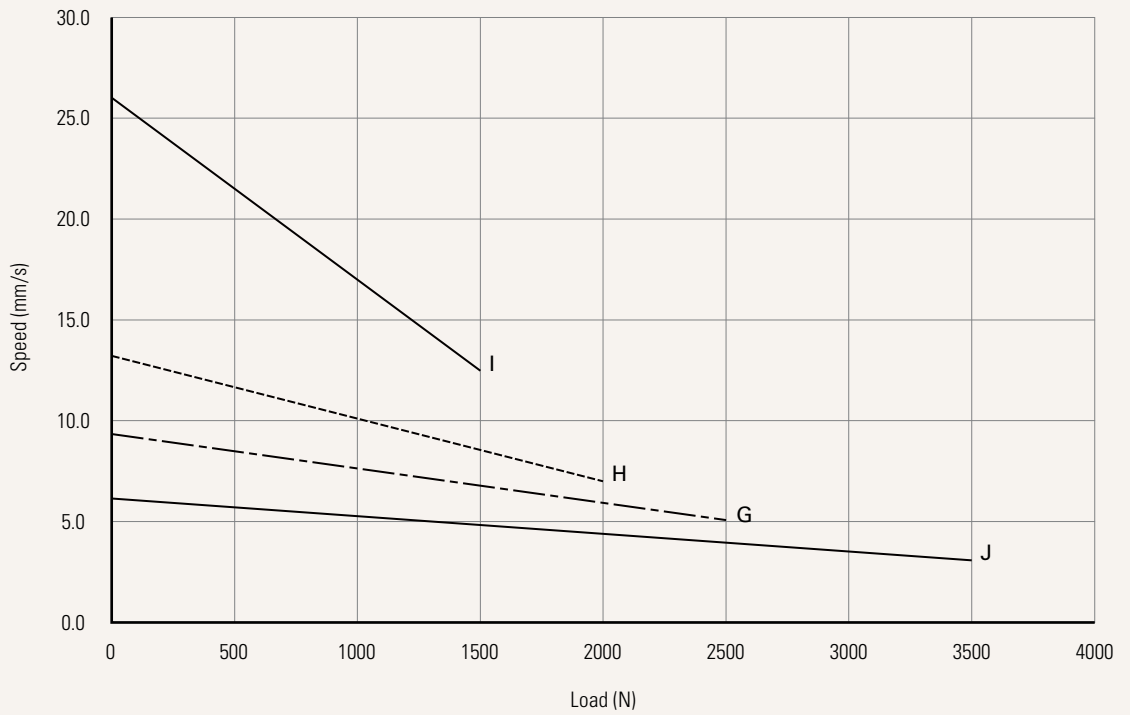

Current vs. Load

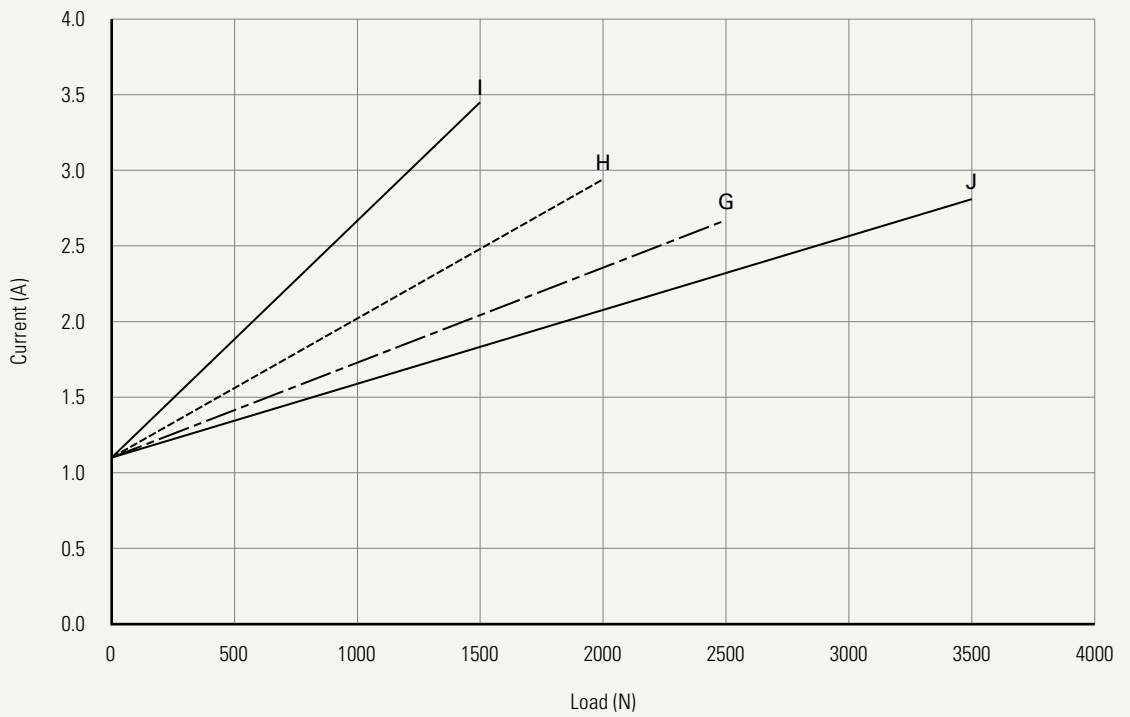

Performance Data (24V DC Motor)

Motor Speed (3400RPM)

Speed vs. Load

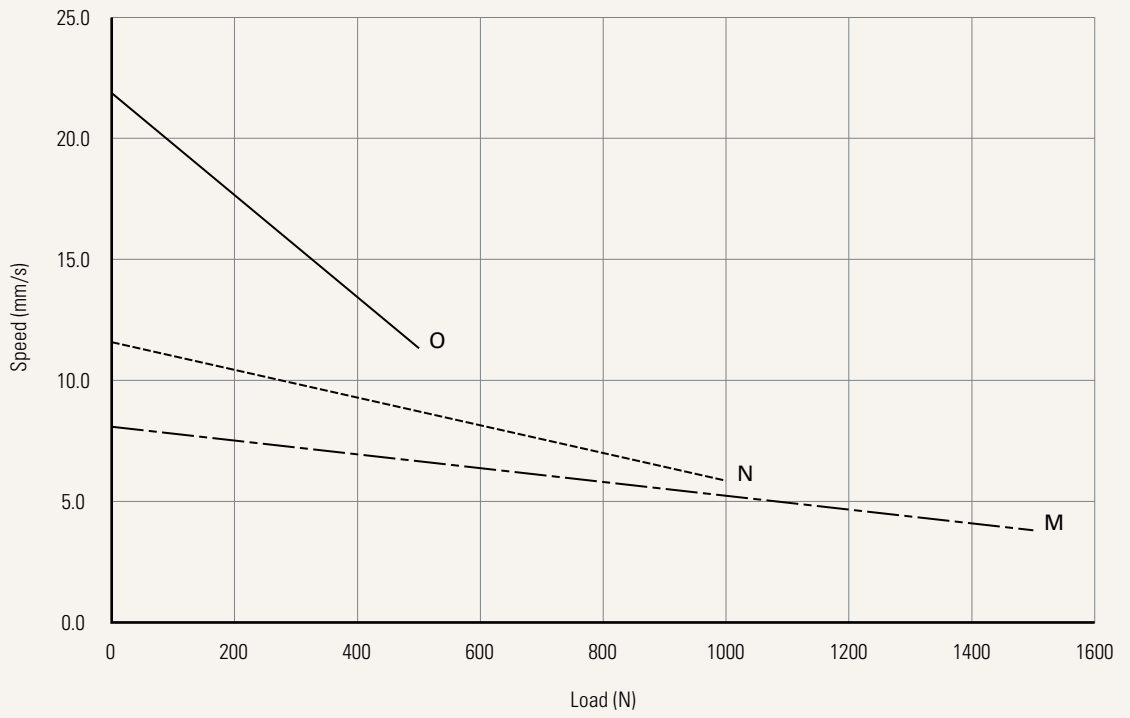

Current vs. Load

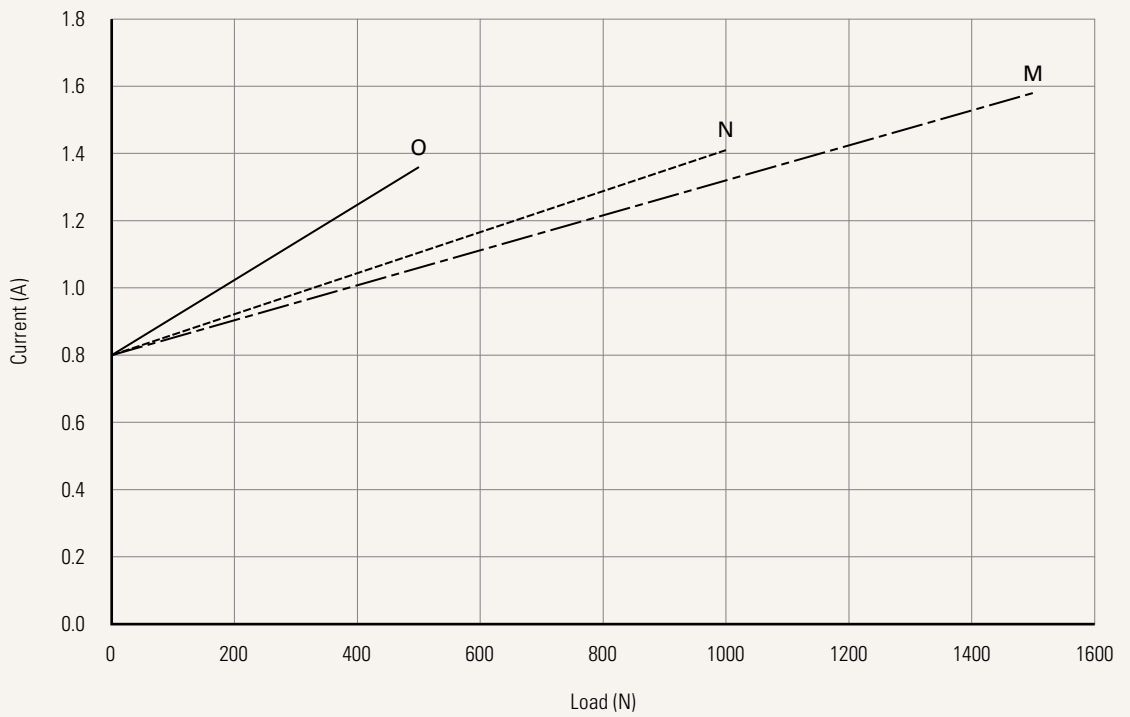

Performance Data (24V DC Motor)

Motor Speed (2200RPM)

Speed vs. Load

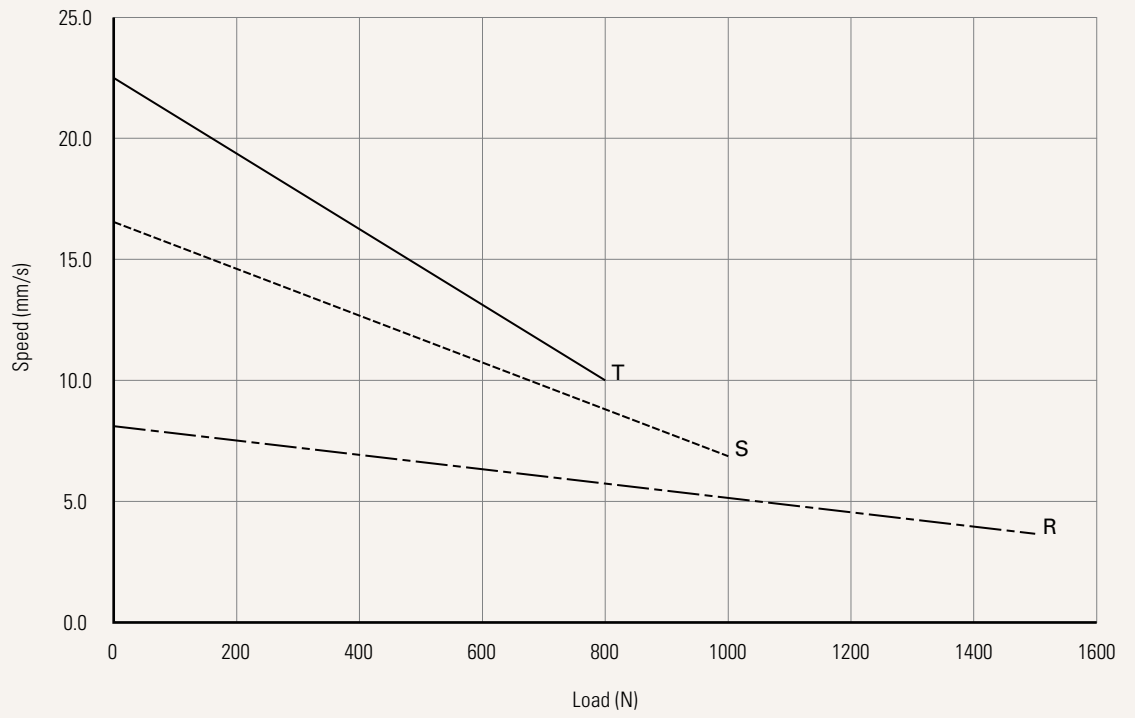

Current vs. Load

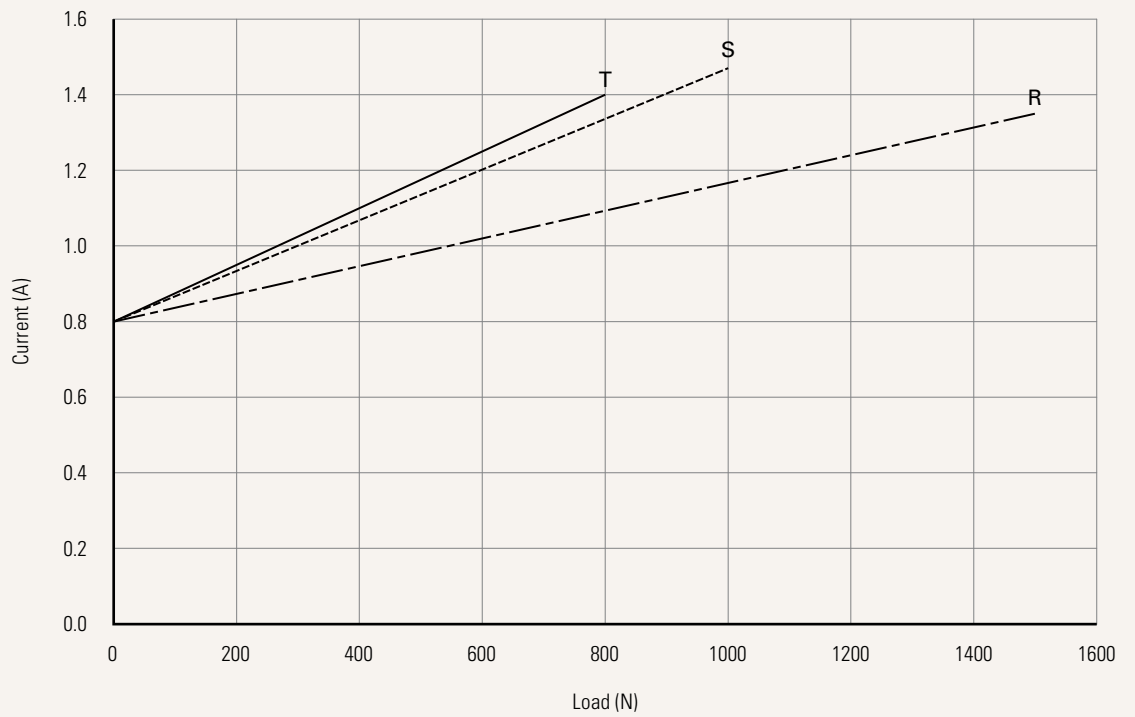

Voltage	1 = 12V DC	2 = 24V DC	5 = 24V DC, PTC
Load and Speed	See page 3		
Stroke (mm)	See page 3		
Retracted Length (mm)	See page 9		
Rear Attachment (mm) See page 10	1 = Aluminum casting, U clevis, slot 6.0, width 11.0, hole 6.4 2 = Aluminum casting, U clevis, slot 6.0, width 11.0, hole 8.0 3 = Aluminum casting, U clevis, slot 6.0, width 11.0, hole 10.0		
Front Attachment (mm) See page 10	1 = Aluminum casting, hole 6.4 2 = Aluminum casting, hole 8.0 3 = Aluminum CNC, U clevis, slot 6.0, depth 16.0, hole 10.0 4 = Aluminum CNC, U clevis, slot 6.0, depth 16.0, hole 6.4 5 = Aluminum CNC, U clevis, slot 6.0, depth 16.0, hole 8.0		
Direction of Rear Attachment See page 10	1 = 0°	2 = 90°	
IP Rating	1 = Without	2 = IP54	3 = IP66
Special Functions for Spindle Sub-Assembly	0 = Without (standard)	2 = Standard push only	
Functions for Limit Switches See page 11	1 = Two switches at full retracted / extended positions to cut current 2 = Two switches at full retracted / extended positions to cut current + third one in between to send signal 3 = Two switches at full retracted / extended positions to send signal 4 = Two switches at full retracted / extended positions to send signal + third one in between to send signal		
Output Signals	0 = Without	5 = Hall sensor * 2	
Connector See page 11	1 = DIN 6P, 90° plug 2 = Tinned leads 3 = Small 01P, plug	B = Y cable (for direct cut system, non water proof, non anti pull) E = Molex 8P, plug	
Cable Length (mm)	1 = Straight, 300	2 = Straight, 600	3 = Straight, 1000 B-H = For direct cut system, See page 11

Retracted Length (mm)

1. Calculate $A+B+C = Y$
2. Retracted length needs to \geq Stroke + Y

A. Front Attachment

1, 2	+140
3, 4, 5	+160

B. Load (N)

< 3500	-
= 3500	+5

C. Stroke (mm)

20~150	-
151~200	-
201~250	+5
251~300	+10
301~350	+15
351~400	+20
401~450	+25
451~500	+30
501~550	+35
551~600	+40
601~650	+45
651~700	+50
701~750	+55
751~800	+60
801~850	+65
851~900	+70
901~950	+75
951~1000	+80

Rear Attachment (mm)

1 = Aluminum casting, U clevis, slot 6.0, width 11.0, hole 6.4

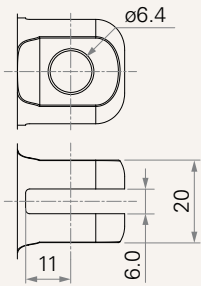

2 = Aluminum casting, U clevis, slot 6.0, width 11.0, hole 8.0

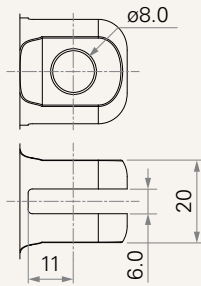

3 = Aluminum casting, U clevis, slot 6.0, width 11.0, hole 10.0

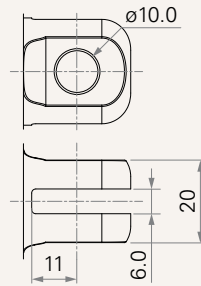

Front Attachment (mm)

1 = Aluminum casting, hole 6.4

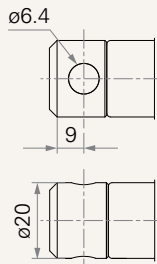

2 = Aluminum casting, hole 8.0

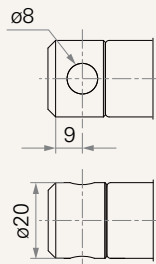

3 = Aluminum CNC, U clevis, slot 6.0, depth 16.0, hole 10.0

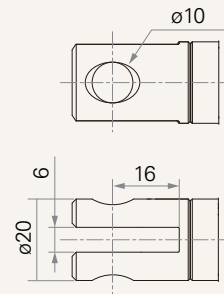

4 = Aluminum CNC, U clevis, slot 6.0, depth 16.0, hole 6.4

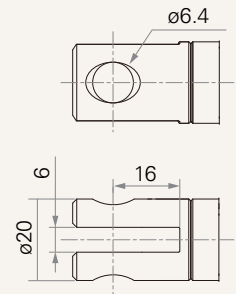

5 = Aluminum CNC, U clevis, slot 6.0, depth 16.0, hole 8.0

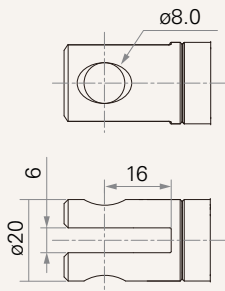

Direction of Rear Attachment

1 = 0°

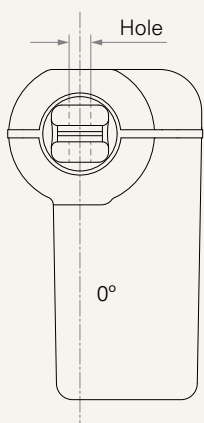

2 = 90°

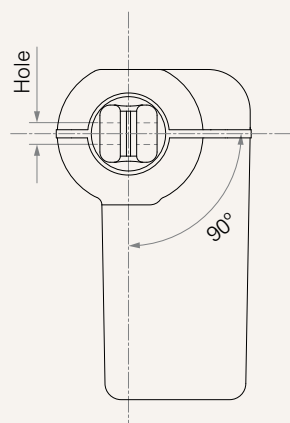

Functions for Limit Switches

Wire Definitions

CODE	Pin					
	● 1 (Green)	● 2 (Red)	○ 3 (White)	● 4 (Black)	● 5 (Yellow)	● 6 (Blue)
1	extend (VDC+)	N/A	N/A	N/A	retract (VDC+)	N/A
2	extend (VDC+)	N/A	middle switch pin B	middle switch pin A	retract (VDC+)	N/A
3	extend (VDC+)	common	upper limit switch	N/A	retract (VDC+)	lower limit switch
4	extend (VDC+)	common	upper limit switch	medium limit switch	retract (VDC+)	lower limit switch

Connector

1 = DIN 6P, 90° plug

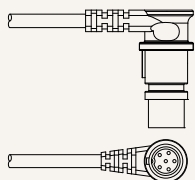

2 = Tinned leads



3 = Small 01P, plug

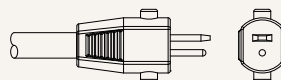

B = Y cable (for direct cut system, non water proof, non anti pull)

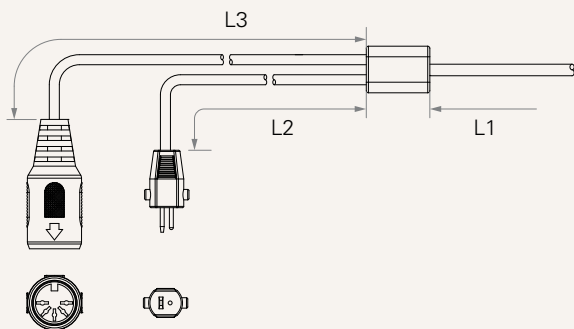

Cable length for direct cut system (mm)

CODE	L1	L2	L3
B	100	100	100
C	100	1000	400
D	100	2700	500
E	1000	100	100
F	100	600	1000
G	1500	1000	1000
H	100	100	1200

E = Molex 8P, plug

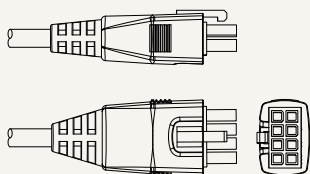

Terms of Use

The user is responsible for determining the suitability of TiMOTION products for a specific application. TiMOTION products are subject to change without prior notice.